

## PAC 18-bit A/D, 1kHz - 3MHz **PCI-2**: The New AE Research Tool

### 2 Channels of Acoustic Emission for Simultaneous Waveforms and Feature Processing

#### **BREAKTHROUGH!**

In 1995, PAC introduced 16-bit 20 MHz A/D for AE. Now with the PCI-2, we are introducing our 18-bit **40 MSamples/sec** A/D for Lower Noise and Higher Speed.

#### Standard PCI

Pioneering a new 18-bit A/D architecture, the **PCI-2** is a low cost, 2-channels of simultaneous Acoustic Emission (AE) waveforms and features digital signal processing (DSP) system on a single full-size 32-bit PCI-Card, ready for operation in your PC or one of PAC's hardened PCs (for multiple channel operation).

#### Superior Noise Performance and Speed ...ideal for Research/Universities

Superior low noise and low threshold performance have been achieved with this revolutionary AE system design, through the use of an innovative **18-bit A/D conversion scheme**, with up to 40 MSample/second acquisition and real time sample averaging. Via the system's pipelined, real-time architecture, this performance is attained without sacrificing AE throughput speed.

With these features and its very low cost, the PCI-2 is ideal for laboratories, universities and industrial turnkey systems, and any application where low noise, low channel count and low cost are required, as well as where the use of an existing PC is desired.

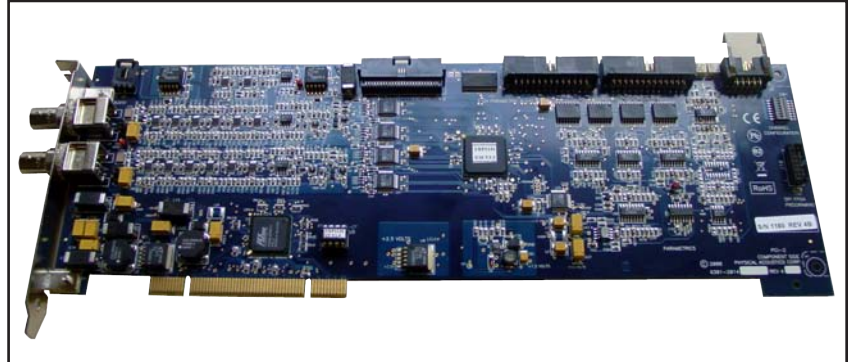

Figure 1. PCI-2 AE System on a card

Through the high-performance PCI (Peripheral Component Interconnect) bus and Direct Memory Access (DMA) architecture, significant AE data transfer speeds can be attained, assuring a wide bandwidth bus for multichannel AE data acquisition and waveform transfer. In addition to two AE channels, the system also has **eight (8) parametric channels** for other transducers, such as strain gage, pressure, temperature, load, and more.

#### Data Streaming... Choice of AE Systems

Waveform data streaming capability is built within the board, allowing waveforms to be continuously transferred to the hard disk. The 32-bit PCI bus is the de-facto standard in all PC computers being shipped today. PCI-2 AE System cards can be implemented inside most standard PC computers or inside one of PAC's rugged, multichannel PAC system chassis, including the 8-channel benchtop chassis, the 12-channel portable AE system or a 4-channel notebook based chassis ( $\mu$ -series).

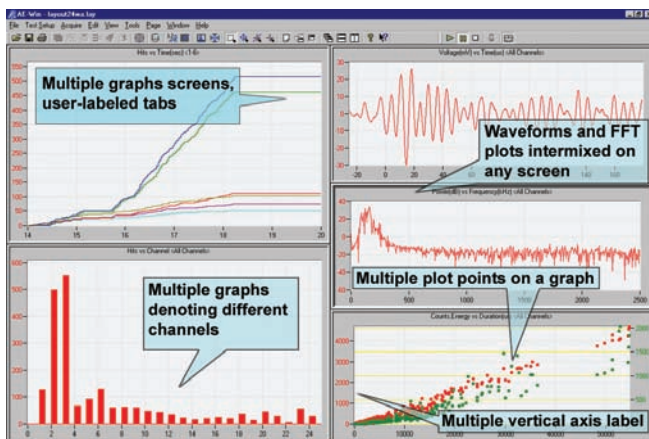

Figure 2. Simultaneous display of AE features and waveforms

#### Applications:

- ◆ Composite materials
- ◆ Aerospace structures
- ◆ Guided lamb wave systems
- ◆ Civil structures, concrete, steel
- ◆ Advanced materials testing
- ◆ Machine Monitoring, Tool touch and wear
- ◆ Acousto/Ultrasonic systems
- ◆ Ceramics high-resolution ultrasonic imaging
- ◆ On-line monitoring systems for bridges, composite structures, process control
- ◆ Tensile testing of samples and coupons

## PCI-2 Acoustic Emission System on a Card

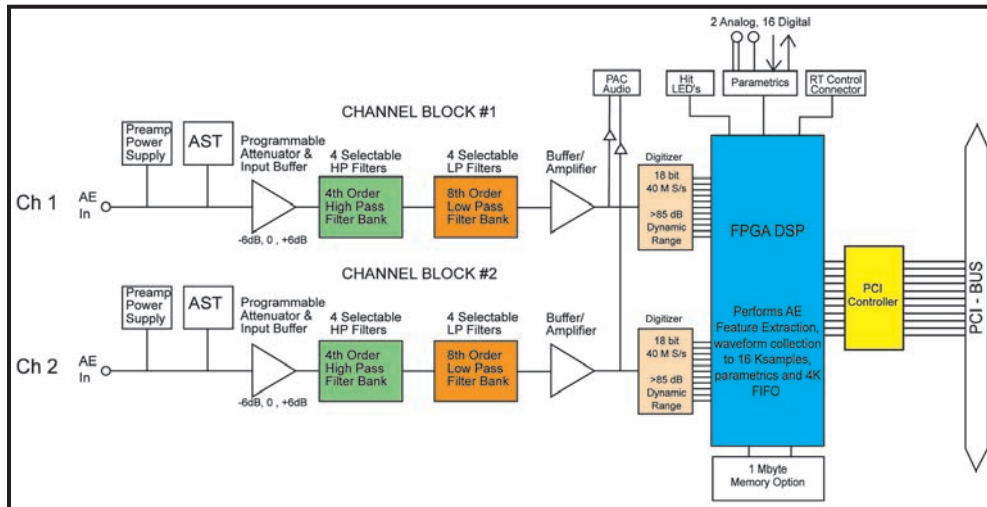

Figure 3. PCI-2 AE System block diagram.

### Advanced Manufacturing. . .ISO Environment

Due to advances in surface mount technology and high density ASIC (high density Programmable Gate Arrays) devices, PAC has been able to provide this single AE System on a board with 2 complete high-speed AE channels of real time AE data acquisition, with real time feature extraction, waveform processing and transfer, eight (8) analog parametric input channels and 8 digital input and output control signals.

*. . .breakthrough A/D, speed, noise, quality and price. . .*

### User Friendly . . .by Design

- Software available for the PCI-2 includes the state-of-the-art **PACwin™ Software Suite**. With 30 years of Acoustic Emission application experience behind it, this Suite is comprised of three individual software packages (purchased separately); these are: **AEwin™** real-time Windows acquisition, replay and analysis software, **AEwinPost™** post analysis software and **NOESIS™**, the most complete Pattern Recognition (supervised or unsupervised) and Neural Networks software in the AE and NDT market today.

### Key Features . . . of the PCI-2 include

- ♦ **Very low noise**, low cost, 2 channel complete, AE system on a card, with waveform and hit processing built in, on one full size, industry standard, 32-bit PCI card.
- ♦ Internal **18-bit A/D conversion** and processing for better resolution (less than 1 dB) at very low signal amplitudes, and low threshold settings, providing superior low noise performance.
- ♦ **40 MHz, 18-bit A/D conversion** with real time sample averaging (2x or 4x) to provide enhanced accuracy beyond any existing AE system on the market.
- ♦ Built-in, **real time AE feature extraction** and DMA transfer on each channel for high speed transient data analysis at high hit rates directly to the Hard Disk (HD).
- ♦ Built-in **waveform processing** with independent DMA transfer on each channel for high speed waveform transfer and processing.
- ♦ Designed with extremely high density FPGAs and ASIC ICs, to provide extreme high performance and minimize components and cost.
- ♦ 4 High Pass and 6 Low Pass **filter** selections for each channel, totally **under software control**.
- ♦ **AE Data Streaming** is also built into the PCI-2 board allowing continuous recording of AE waveforms to the hard disk at up to 10 MSamples/sec rate (on one channel, 5 MSamples/second on 2 AE channels).
- ♦ Up to **8 parametrics** on each PCI-2 board with **16-bit A/D** converter and update rates up to 10,000 readings/second. The first parametric is a full **Instrumentation conditioning** channel providing signal conditioning including gain control, offset control and filtering options for direct sensor input. The second provides a straight +/- 10 volt input for conditioned sensor outputs.
- ♦ Hit LED, and Audio drivers are built within the PCI-2 board, so that LEDs can be attached directly and sound can be processed via the PAC PCI-Audio Card (option).
- ♦ Digital signal processing circuitry virtually eliminates drift, thereby achieving high accuracy and reliability.



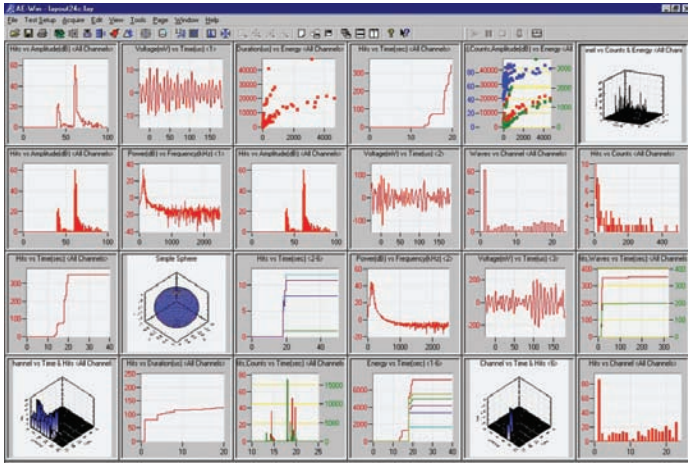
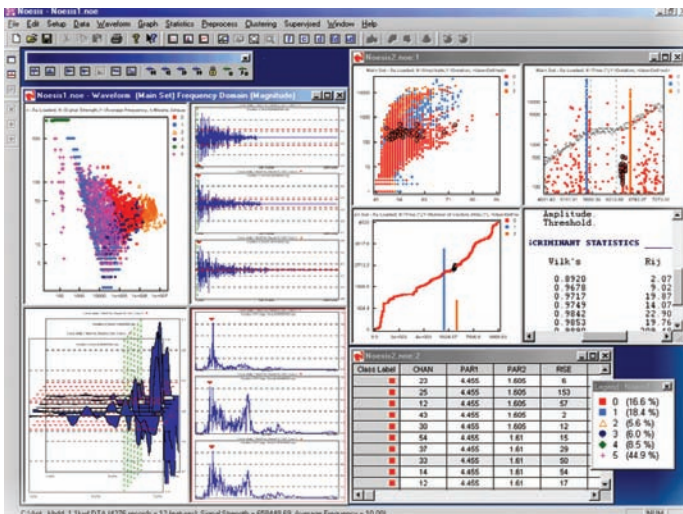

**Figure 4.** Many graphs per screen can be viewed in real time or replay. This screen shows some of the flexibility of AEwin™. In this overview, 2D and 3D graphs, waveforms, FFT's, line graphs, histograms, multi-plot graphs, etc. are shown.

- **Front Panel** activity lights are totally under the control of your PC to provide status on AE data as well as to give you indication of any malfunctioning of your system.
- **Audio** drives ready for high fidelity listening with your PAC PCI-Audio Card.
- **Auto Sensor** testing standard with all PAC systems for easy system/sensor self calibration and interface coupling efficiency monitoring.

### System Flexibility... by Design

Standard 32-bit PCI hardware and 32-bit Windows AEwin™ software allows the customer maximum flexibility of using a PC or notebook computer. No need to change home made PCs, but ability to take advantage of today's PC speeds readily available with high performance PCI busses. Multiple AE channels (up to 20) are easily synchronized for multiple location algorithms.



**Figure 5.** Noesis™ Software for the PCI-2 is sophisticated, yet user friendly and operates under Windows 2000

### Software... supported by PAC's AE multichannel systems experience since the early 70's

PCI-2 is supported by PACwin™ Software Suite, a PAC Windows Platform consisting of AEwin™, AEwinPost™ and Noesis™ (individually purchased). All software runs in Windows 2000 and XP, thus taking advantage of standard features such as multi-tasking, graphic user interfaces, etc. and providing the ability to change AE parameters during test operation.

Multiple location algorithms are available including zohal, linear, planar, tank bottom, cylindrical, spherical (with ASME weld zones), conical, 3-D, advanced Non-Linear Regression (NLR) location, anisotropic 2-D, anisotropic cylinder and over-determined planar location for exceptional accuracy. All location algorithms utilize attenuation tables/curves, auto-sensor placement, and source corrected amplitude for more accurate location and AE intensity calculation.

### PCI-2 Specifications:

#### Physical:

- **Size:** 13.415" L x 4.3" H x 0.7" T
- **Weight:** 1.1 lbs.
- **Power Consumption:** 12 Watts
- **DC Power:** +12.0 volts, 1.0 amps  
-12.0 volts, 0.05 amps  
+5.0 volts, 1.5 amp

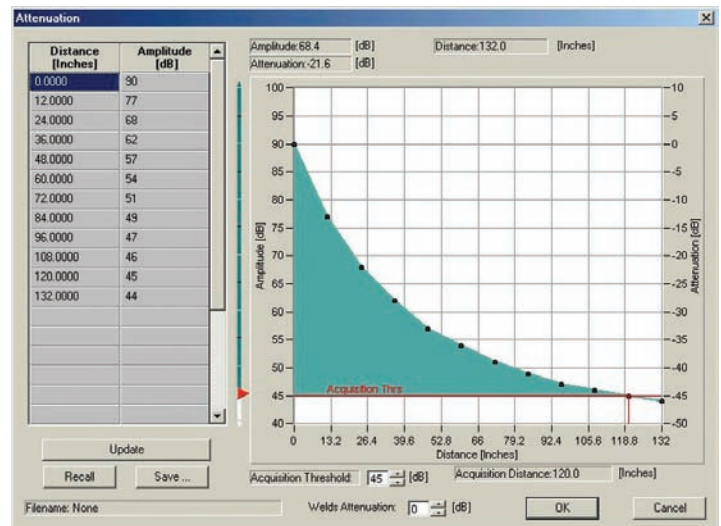

**Figure 6.** AEwin™ Software can use an attenuation profile of the AE response on the structure. This information is important in determining the source amplitude of an AE event. Attenuation profiles can easily be constructed and displayed in tabular and graphical form. They can be saved and recalled. AEwin™ automatically determines the amplitude at the source (Source Amplitude) and provides this as a graphable AE feature.

## PCI-2 Acoustic Emission System on a Card

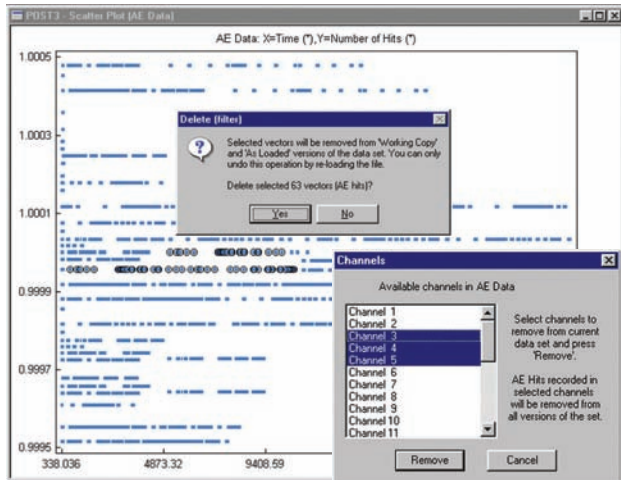

Figure 7. AEwinPost™ offers a number of ways to filter data including: Select – Delete operation. Simply select the data to be filtered and press delete; filtering via graphical filters; and dedicated channel filters.

### PCI-2 Specifications (continued):

#### Environmental:

- **Operating Temperature:** 41° – 115° F (5° - 45° C)
- **Storage Temperature:** -4° – 140° F (-20° - 60° C)

#### Electrical:

- **AE Inputs:** 2 channels
- **Input Impedance:** 50 ohm or 1000 ohm, jumper selectable
- **Preamplifier Power:** Jumper selectable 0 volt or 28 VDC, 100 ma current limited (on BNC center conductor for phantom powering of external preamplifiers)
- **Sensor Testing:** AST built-in
- **Frequency Response:** 1 kHz – 3 MHz (at -3 dB points)

#### Signal Processing:

- **AE Signal Gain:** 0dB, 6 dB computer selectable input signal scaling
- **Filters:**
  - 4 **High Pass** - computer selectable filters 1 kHz, 20 kHz, 100 kHz, 200 kHz, 4<sup>th</sup> order Butterworth
  - 6 **Low Pass** - computer selectable filters 100 kHz, 200 kHz, 400 kHz, 1 MHz, 2 MHz, 3 MHz, 6<sup>th</sup> order Butterworth
- **Noise: Min. Threshold:** 17 dB without AE Sensor, 22 dB with (1 kHz - 3 MHz bandwidth) R15 AE Sensor and 2/4/6 preamplifier, 24 dB with R15I Integral Preamp sensor

Note: Lower noise will be achieved using narrow band filtering

- **ASL Noise:** 4 dB maximum, (with no input)
- **Max. Signal Amplitude:** 100 dB AE ASL99 dB
- **ADC Type:** 18 bit 40 MSPS per channel maximum

- **Dynamic Range:** > 85 dB, 2 kS/s, 5 kS/s, 10 kS/s, 20 kS/s, 50 kS/s
- **Sample Rate:** Computer selectable 100 kS/s, 200kS/s, 500kS/s, 1M-Samples/sec, 2 MSPS, 5 MSPS, 10 MSPS, 20 MSPS, 40 MSPS
- **Sample Averaging:** 40 MSPS with 2x averaging, for a 20 MSPS effective sample rate
- **Extracted AE Features:** Time of 1<sup>st</sup> Threshold Crossing, Counts to Peak, Peak Amplitude, Signal Strength, Duration, Rise Time, Counts, True Energy, RMS, ASL, Parametric 1 & 2.

#### Analog Parametrics:

- **Parametric Channels:** 8 Channels
- **Parametric A/D Resolution:** 16 bits
- **Parametric Sample Rate:** 10 kHz sample rate for each analog parametric
- **Time Driven Data Rate:** Controlled by software 10 msec. to 1800 seconds
- **Time Parametrics:** All 8 parametrics are available in time data set
- **Parametric #1,3,5,7 Functions:**
  - Computer selectable Input Range ± 10.0v, ±1.0 v, ±0.10v, ±0.01v
  - Computer selectable 30 Hz Low Pass filter or none
  - 5.0 V software programmable offset control with 12 bit DAC
  - 0 – 10 volt programmable excitation voltage for strain gage bridges
- **Parametric #2,4,6,8 Functions:**
  - Parametric Input Range ± 10.0 v fixed, no filter

#### Digital I/O:

8 Digital Inputs, 8 Digital Outputs (5 v tolerant), TTL level compatible)

#### AE Out and Audio Monitor Interface:

Analog switch and buffer to select desired AE channel to be routed to standard PAC audio monitor board or AE output signal

#### LED Activity Monitor:

On board LED driver to directly drive LED's on front panel. LED minimum on-time is 0.05 seconds.

**For more information:**

**Call (609) 716-4000**

**or Email us at [sales.systems@mistrasgroup.com](mailto:sales.systems@mistrasgroup.com)**

**Visit our website at:**  
**[www.mistrasgroup.com](http://www.mistrasgroup.com)**



195 Clarksville Road, Princeton Junction, NJ 08550 USA  
Phone: (609) 716-4000 • Fax: (609) 716-0706  
Email: [sales.systems@mistrasgroup.com](mailto:sales.systems@mistrasgroup.com) • [www.mistrasgroup.com](http://www.mistrasgroup.com)